

SmartPower Stacks™ Spec Sheet

Level 1: 100 kW DC-DC Converter

Model Number: SPS135B3DD120E

Key Data

1 Phase Converter Configuration

Rated output: 100kW

General Information

Standard configuration includes: (3) IGBT Modules, (3) Gate Drive Boards, (3) Current Sensors, Interface Board & Heat Sink

Topology	Single Phase Inverter
Application / Modulation	Inverter / Sine or Custom
Load Type	Resistive, Inductive
Standards	UL 508C
Cooling	Forced Air (fan optional)
Markets	Solar, Wind, UPS, Battery Storage, Motor Control, Power Conversion Applications.
Current Sensors	LEM – HASS 400-S
IGBT Modules	FUJI – Electric DualXT – 2MBI450VN-120 &-120S
Gate Drive Boards	AgileSwitch – AS2-EconoDual Electrical
Interface Board	AgileSwitch – ASI-PS
Heat Sink	Methode – High Performance Extruded

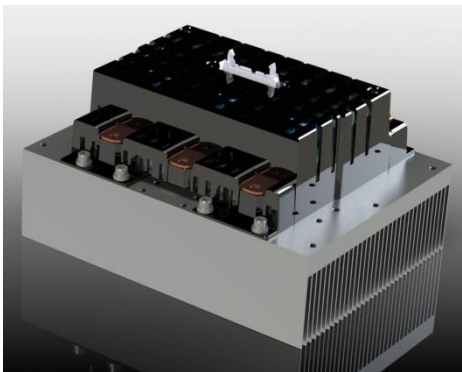

SmartPower Stack Topology

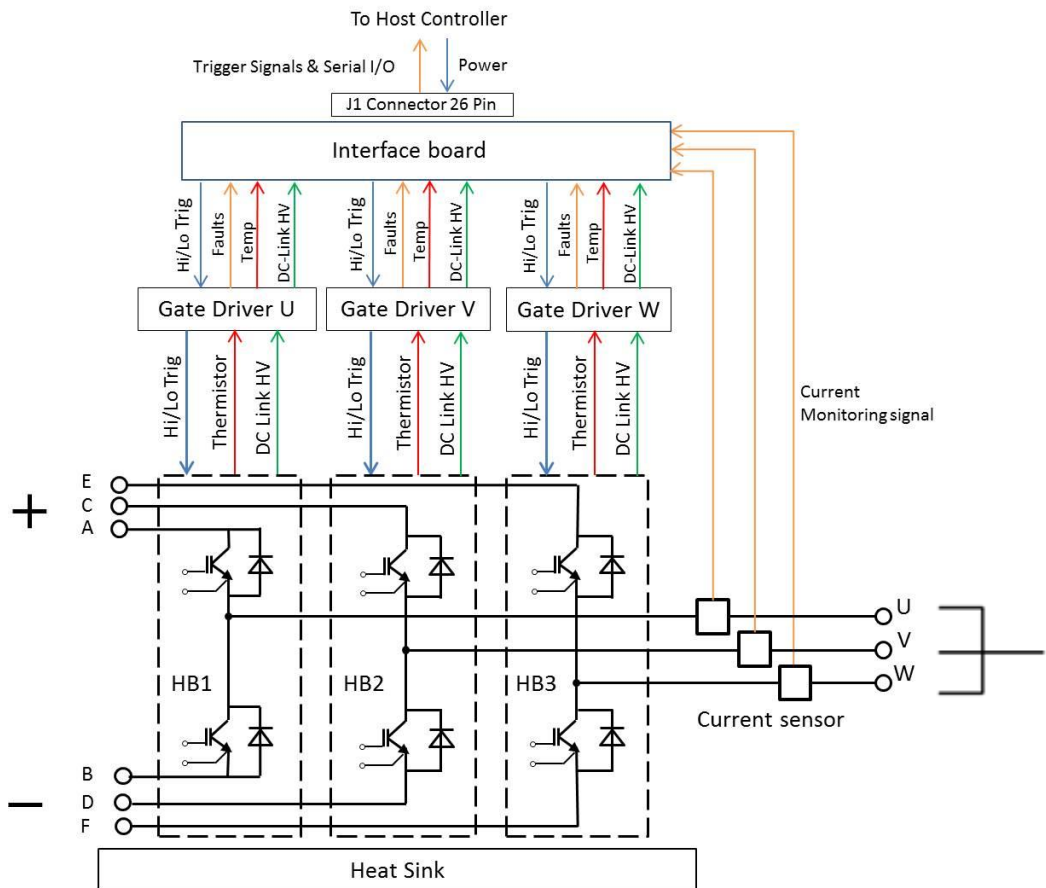

*DC link capacitors and Controller Optional

Prepared by: Rob Weber	Version: v13.0
Approved by: Mike Stibgen	Effective Date: 09/03/2014

SmartPower Stacks™ Spec Sheet

Level 1: 100 kW DC-DC Converter

Note: Operating Conditions:

$V_{DC_IN}=680$, $V_{DC_OUT}=480$, $F_{SW}=5\text{kHz}$, $\cos(\varphi)=.9$, airflow = 485 m³/hr, air temp = 25°C, $I_{DC_OUT}=208$

Electrical Characteristics

DC Link	Notes	Symbol	min	typ	max	unit
DC link Voltage	Continuous Operation	V_{DC}	280		900	V
Max Surge Voltage	2 min, non-operational				1200	V
Overvoltage Shutdown	Configurable		880	900	920	V

AC Data	Notes	Symbol	min	typ	max	unit
Voltage		V_{AC}			635	V_{rms}
Continuous Current	See Typical Operating Conditions	I_{AC}		208	450	A_{rms}
Power Loss	See Typical Operating Conditions	P_{loss}		1800		W
Switching Freq ¹	See Typical Operating Conditions. Max frequency is @ 50°C	F_{SW}		5	10	kHz
Power Factor	Leading or Lagging	$\cos(\varphi)$	0		1	
Surge Current	Max for 10 μ s				2700	A_{rms}

General Data	Notes	Symbol	min	typ	max	unit
High Voltage IGBT to Heat Sink				3.0		kV AC
High Voltage IGBT to J1 Connector				3.0		kV AC
High Voltage IGBT to J1 Connector – Creepage/Clearance			8.0			mm
High Voltage IGBT Connections and Circuits to Heat Sink			8.0			mm

Heat Sink Air Cooled/Thermal Data

Data	Notes	Symbol	min	typ	max	unit
Airflow	See Typical Operating Conditions	$\Delta V/\Delta t_{Air}$		485		m ³ /hr
Air Pressure Drop		ΔP_{Air}		410		Pa
Cooling Air Inlet Temperature	Typical Operating Conditions are supported over this operating range, including Tmax.	T_{inlet}	-25	25	50	°C

Environmental Conditions

Data	Notes	Symbol	min	typ	max	unit
Storage Temp	Non-operational	T_{stor}	-40		85	°C
Maximum allowed heat sink temperature					90	°C
Ambient Temp	Continuous Operation	T_{Amb}	-25		50	°C
Altitude above sea level	Derated operation possible above Alt Max	Alt			1000	m
Air Pressure	Standard Atmosphere	P_{air}	900		1100	hPa
Humidity	Non-condensing	Rel. F	5		85	%
Pollution Degree				2		
Total Weight				13		kg
Weight w/o Heat Sink				7.6		kg
Dimensions	L x W x H		280	215	165	mm
Heat Sink Dimensions	L x W x H		280	215	80	mm
Torque at AC terminals		M_{AC}	16		20	Nm

Prepared by: Rob Weber

Version: v13.0

Approved by: Mike Stibgen

Effective Date: 09/03/2014

SmartPower Stacks™ Spec Sheet

Level 1: 100 kW DC-DC Converter

IGBT Module Data – Fuji 2MBI450VN-120 & -120S

Module Absolute Maximum Ratings	Notes	Symbol	min	typ	max	unit
Collector-Emitter Voltage		V_{ces}			1200	V
Gate-Emitter Voltage		V_{ges}			20	V
Collector Current	Continuous	I_c			450	A
Collector Current	Pulse 1ms	I_{c_pulse}			900	A
Collector Power Dissipation	1 Device	P_c			2270	W
Junction Temperature	Maximum / Operating	T_j			175/150	°C
Isolation Voltage	Terminals to baseplate, 1 min	V_{iso}			2500	VAC

IGBT Data	Notes	Symbol	min	typ	max	unit
Collector-Emitter Saturation voltage	$I_c=300A, V_{ge}=15V, T_j = 150^\circ C$	V_{ce_sat}		2.7		V
Parameter for linear model	$T_j = 25^\circ C$	V_{ce1}		1.0		V
Parameter for linear model	$T_j = 25^\circ C$	R_{ce1}		2.5		mΩ
Parameter for linear model	$T_j = 150^\circ C$	V_{ce2}		0.95		V
Parameter for linear model	$T_j = 150^\circ C$	R_{ce2}		3.9		mΩ
Thermal resistance junction to case		R_{thjc}			.094	K/W
Thermal resistance case to heat sink		R_{thch}			.0167	K/W

Diode Data	Notes	Symbol	min	typ	max	unit
Thermal resistance junction to case	For one device	R_{thjc}			.1	K/W
Thermal resistance case to heat sink	For one device	R_{thch}			.0167	K/W

Collector current vs. Collector-Emitter voltage (typ.)
 $T_j = 25^\circ C / \text{chip}$

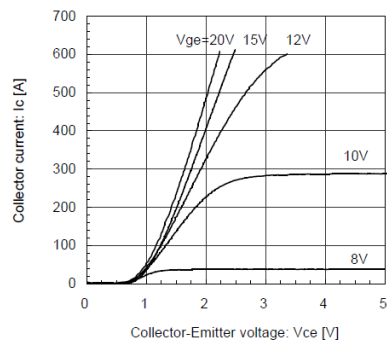

Collector current vs. Collector-Emitter voltage (typ.)
 $T_j = 150^\circ C / \text{chip}$

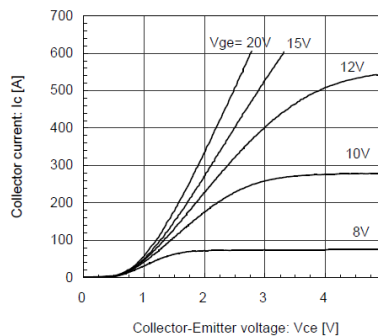

Switching loss vs. Collector current (typ.)
 $V_{cc}=600, V_{ge}=\pm 15V, R_g=0.93\Omega, T_j=125^\circ C, 150^\circ C$

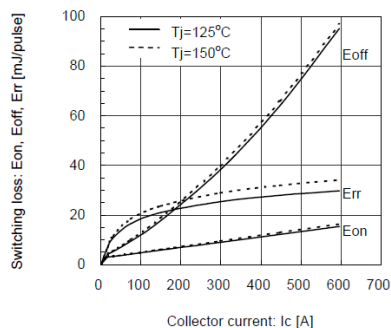

Forward Current vs. Forward Voltage (typ.)
diode

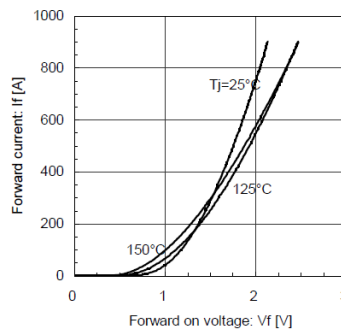

Prepared by: Rob Weber

Version: v13.0

Approved by: Mike Stibgen

Effective Date: 09/03/2014

SmartPower Stacks™ Spec Sheet

Level 1: 100 kW DC-DC Converter

External Input/Output Data

Input

DC Link Bus Connections A+, B-, C+, D-, E+, F-

There are 6 DC Link Bus Connections. These connections are positive and negative connections to the 3 Half Bridge (here by referred to as 'HB') sections in the SmartPower Stack.

Item	Description/Value
Bus Connections A+, C+, E+	Positive high voltage bus connections to HI Side collector of each HB
Bus Connections B-, D-, E-	Negative high voltage bus connections to LO Side emitters of each HB
Mounting Holes	M6x1 – 16 mm

Controller/Power to Interface Board – J1

Detailed connection data on previous page.

Output

Connections U, V, W

There are three output connectors. These connectors are located at the center point output of each HB.

Item	Description/Value
Bus Connections U, V, W	High Voltage DC Output
Mounting Holes	M8x1.2 – 25 mm

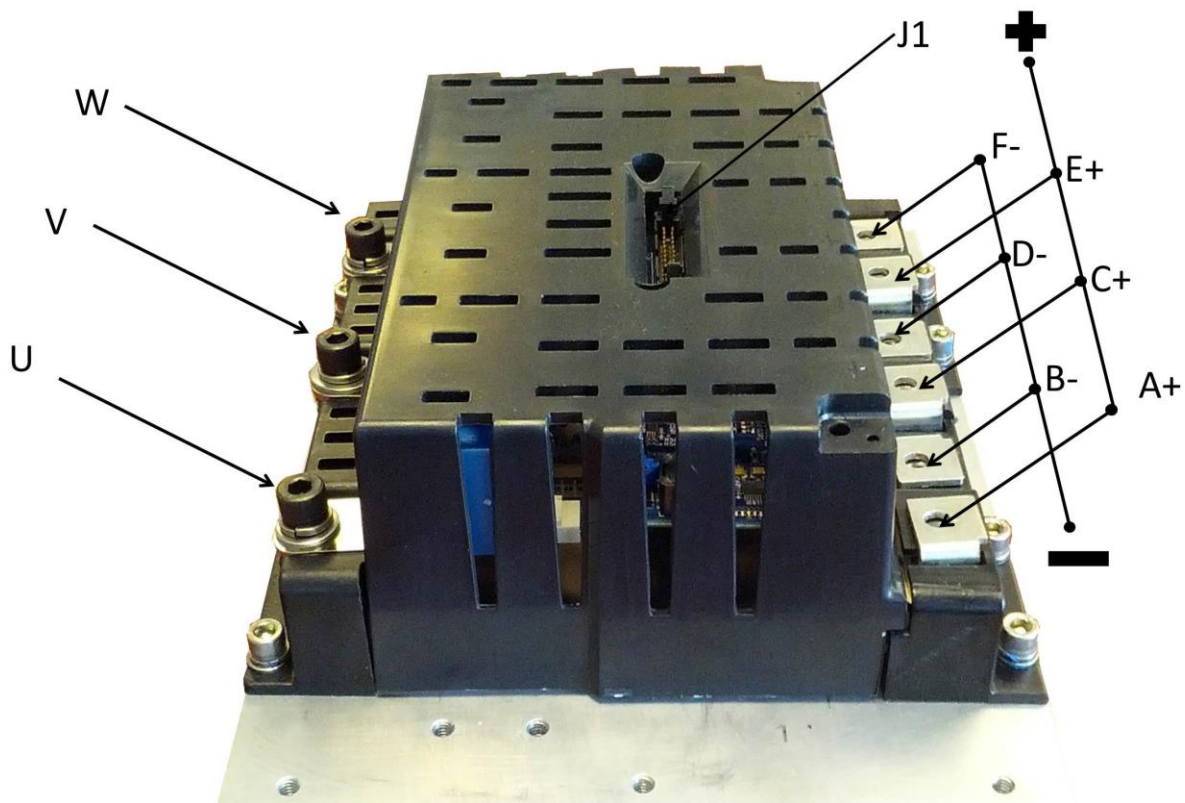

Prepared by: Rob Weber	Version: v13.0
Approved by: Mike Stibgen	Effective Date: 09/03/2014

SmartPower Stacks™ Spec Sheet

Level 1: 100 kW DC-DC Converter

Specification for Over Current Protection

For applications requiring fuse protection, the fuse should have the following characteristics:

Category	Notes	Value	Unit
Maximum Fuse Rating Input and Output (A)		400	A
Maximum I ² T		17.0	kA ² s

Controller Interface Data

Data	Notes	Symbol	min	typ	max	unit
Power Voltage Input		V _{in}	13	24	30	V
Power Input ⁽¹⁾	V _{in} = 24V	P _{aux}			30	W
Driver board	See separate spec sheet for details	AS2-Econodual Electrical				
Input Signal Logic Hi Level	10kΩ to GND, 1nF to GND	V _{in_hi}	11	15	17	V
Input Signal Logic Lo Level		V _{in_lo}	-0.5	.5	2	V
Digital Output Level	Open collector, low=ok, max sink: 15mA	V _{out}	0	-	30	V
Analog Output Format	0-10V, max source 15mA					
DC Voltage Measurement range	DC Voltage Corresponds to 0V to +12V analog range Current Output analog voltage is -12V to +12V Temperature output voltage is Corresponds to 0V to +10V	V _{dc_range}	100	-	1000	V
AC Current Measurement range		I _{ac_range}	-2700	-	+2700	A
Temperature Measurement range		T _{range}	-40	-	150	°C

(1) The Current Input of the 24V supply should be current limited or fused to 3A.

Controller/Power to Interface Board (J1) Connectors Data

J1 Connector PINOUT Descriptions

Pin No	Signal	Pin No	Signal
1	SHIELD	2	BOT-HB1-IN
3	ERROR-HBI-OUT	4	TOP-HB1-IN
5	BOT-HB2-IN	6	ERROR-HB2-OUT
7	TOP-HB2-IN	8	BOT-HB3-IN
9	ERROR-HB3-OUT	10	TOP-HB3-IN
11	OVERTEMP-OUT	12	RESERVED, MUST LEAVE NC
13	VDC-LINK	14	VCC – +24V Supply Voltage
15	VCC – +24V Supply Voltage	16	+15V
17	+15V	18	GND
19	GND	20	TEMP-SENSE-OUT
21	Aux GND	22	I-SENSE1-OUT
23	Aux GND	24	I-SENSE2-OUT
25	Aux GND	26	I-SENSE3-OUT

J1 Connector Hardware

Connector	Type	Manufacturer Part Number
Ribbon Cable	26 Pins	TE Connectivity 1658622-6
Interface Board	26 Pins	TE Connectivity 5499923-6

Prepared by: Rob Weber	Version: v13.0
Approved by: Mike Stibgen	Effective Date: 09/03/2014

SmartPower Stacks™ Spec Sheet

Level 1: 100 kW DC-DC Converter

Temperature, Voltage and Current Monitor Output

AgileSwitch SmartPower Stacks implement five analog output signals available on J1, on the 26 pin output connector.

Temperature (TEMP-SENSE-OUT PIN 20)

The temperature monitor signal is an analog output voltage with a 0V to 11V range that represents the temperature of the IGBT thermistor in the center IGBT half bridge (HB) leg in the SmartPower Stack. The graph below shows the temperature and output voltage relationship. Frequency response = 100Hz

Note: A reading of 10V corresponding to a 110 °C thermistor temperature will generate a fault and shutdown condition.

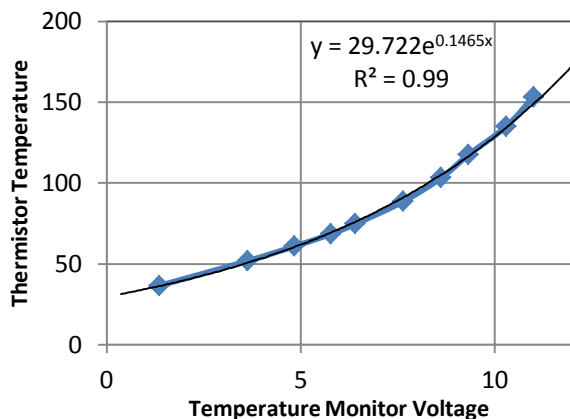

High Voltage (HV) Link (VDC-LINK PIN 13)

The HV monitor is an analog voltage with a range of 0 to 10V. The output voltage represents the voltage on the high side connection of the SmartPower Stack. High Voltage is calculated by the following approximate equation:

$$V_{DC\ LINK} = (102 \times HV_{MONITOR}) + 5V$$

The DC Link Monitor has an accuracy of $\pm 1\%$ from 100V to 950V. The chart demonstrates the relationship between analog output and HV Link Monitor Output Voltage. Frequency response = 1KHz

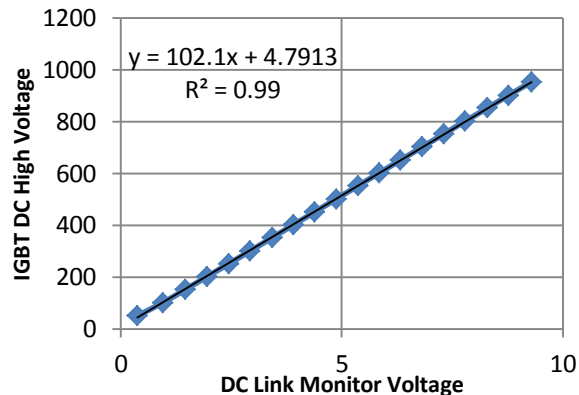

Current (I-SENSE-OUT PINS 22, 24, 26)

The SmartPower Stack has three current monitor signals available for configuration Single Half Bridge Configuration. All three half bridges are triggered in parallel and the total current from all three HB's is indicated by the analog voltage on I-SENSE1-OUT PIN 22 signal. The actual current is calculated by the equation:

$$i_{phase} = 225 \times i_{sv}(x)$$

In addition, the current in HB2 and HB3 is available on I-SENSE2-OUT PIN 24 and I-SENSE3-OUT PIN 26. The output current for these two is the same for the 3 phase configuration:

$$i_{phase} = 75 \times i_{sv}(x)$$

Note: The accuracy of the current sensor is $\pm 1.5\%$. Note that each current sensor has an offset current error of $\pm 3A$ that should be nulled in the system's monitoring software. Frequency response = 10KHz

A current monitor voltage of $\pm 10V$ will generate a fault and shutdown condition.

Prepared by: Rob Weber

Version: v13.0

Approved by: Mike Stibgen

Effective Date: 09/03/2014

SmartPower Stacks™ Spec Sheet

Level 1: 100 kW DC-DC Converter

Protection / Faults

Fault Table

Fault Condition/Action	Generic Sample Default Trigger Values	Action on IGBT if Active
Desat - HI	>7 Volts for 6.1 μ s*	Turn off HI side
Desat - LO	>7 Volts 6.1 μ s*	Turn off LO side
HV Overshoot - HI	Not Applicable*	Active Clamping occurs
HV Overshoot - LO	Not Applicable*	Active Clamping occurs
UVLO - HI	<12 Volts	Turn off HI side
UVLO - LO	<12 Volts	Turn off LO side
Cross Latch/Shoot Through	Attempt to turn on both IGBTs simultaneously	Does not allow turn on of inactive IGBT until active is off for 2 μ s*
DC Link Overvoltage	900 Volts*	Shut down all IGBTs
Overcurrent	2250A	Shut down all IGBTs
Over Temperature	>110 °C	Shut down all IGBTs

Certain parameters are configurable (noted by *).

Fault Reporting Pins (Configurable)

Fault Condition/Action	Pin 3	Pin 6	Pin 9	Pin 11
DSAT HB1	X			
DSAT HB2		X		
DSAT HB3			X	
OVERCURRENT HB1	X	X	X	
OVERCURRENT HB2	X	X	X	
OVERCURRENT HB3	X	X	X	
TEMP	X	X	X	X
DC LINK OV	X	X	X	
UVLO	X	X	X	

"X" = possible to map this fault to this pin

Notes:

- Only 1 fault may be mapped to each pin.
- Though configured as a single Half Bridge, the DC-DC Converter reports if an error has occurred on any of the individual IGBT Modules (Half Bridges) in the system. (Pins 3, 6, 9).
- Temperatures Monitoring is reported from the NTC Thermistor located inside of HB2 in the system (Pin 20).
- Temperature Faults will be triggered for each individual Half Bridge in the system (Pins 3, 6, 9).
- Current Monitoring is reported for each individual Half Bridge in the system (Pins 22, 24, 26).

Prepared by: Rob Weber

Version: v13.0

Approved by: Mike Stibgen

Effective Date: 09/03/2014

SmartPower Stacks™ Spec Sheet

Level 1: 100 kW DC-DC Converter

SmartPower Stack™ Components

 AgileSwitch Interface Board

 AgileSwitch Gate Drivers

 Fuji IGBTs

LEM Current Sensor

 Methode Heat Sink

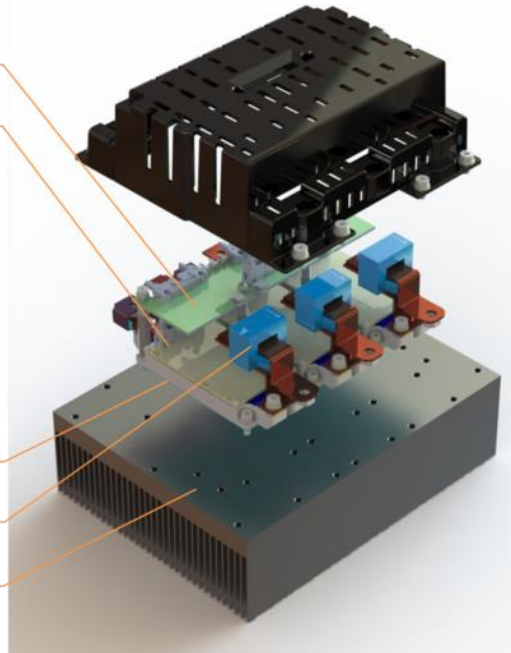

Mechanical Dimensions

Units:
[mm]
inches

[215]
8.5

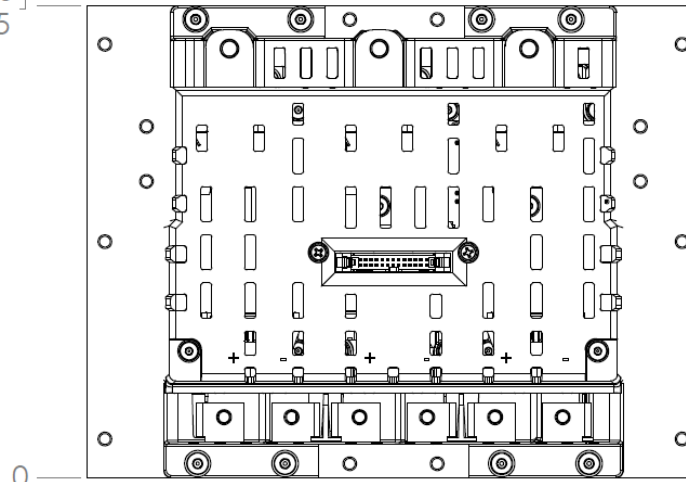

[156]
6.1

[80]
3.1

0

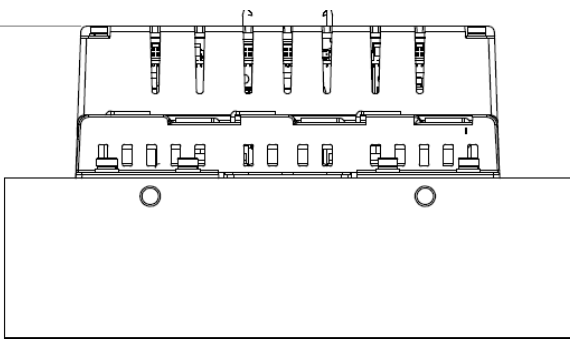

[280]
11.0

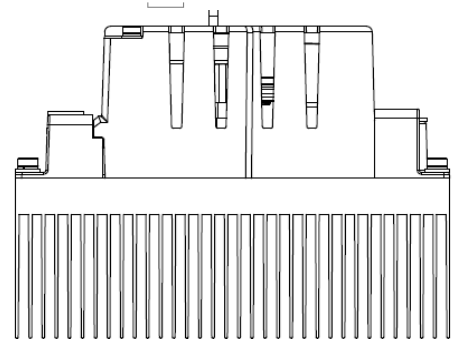

Prepared by: Rob Weber

Version: v13.0

Approved by: Mike Stibgen

Effective Date: 09/03/2014

SmartPower Stacks™ Spec Sheet

Level 1: 100 kW DC-DC Converter

SmartPower Stack™ Consortium

The SmartPower Stack Consortium consists of global leaders in controllers, IGBTs, gate drives, capacitors, bus bar architectures and cooling solutions that have joined to create the industry's first fully integrated, deployment-ready commercial embedded system for high-volume solar, photovoltaic, wind, hybrid electric and electric vehicles, as well as high capacity uninterruptible power supply and efficient motor drive applications.

As part of this effort, National Instruments supplies the controller, I/O, simulation and programming toolset, SBE provides new high performance wound film capacitors, Fuji supplies industry leading IGBTs, AgileSwitch offers leading edge IGBT gate drives and Methode offers state-of-the-art bus bar architectures, thermal management solutions, assembly and test capability.

Together, the five companies are creating fully integrated sub-system solutions for the power electronics industry with the highest performance for energy conversion inverters and convertor systems. This effort represents the industry's first collaboration of best-in-class technologies that are tightly integrated to deliver smart, efficient, reliable and long lasting power conversion.



7401 West Wilson Avenue
Chicago, IL 60706-4548
www.methode.com
mstibgen@methode.com



1650 Arch Street, #1905
Philadelphia, PA 19103
www.AgileSwitch.com
info@AgileSwitch.com



11500 North Mopac Expressway
Austin, TX 78759
www.ni.com
brian.maccleery@ni.com



81 Parker Road
Barre, VT 05641-9106
www.sbelectronics.com



50 Northfield Avenue
Edison, NJ 08837
www.americas.fujielectric.com

Legal Disclaimer

AGILESWITCH and the AGILESWITCH logo are trademarks or registered trademarks of AGILESWITCH, LLC in various countries. Fuji is trademark of FUJI ELECTRIC CO. Ltd. Methode is trademark of Methode Electronics, INC. SBE and Power Ring Film Capacitors are trademarks of SBE. National Instruments is trademark of National Instruments. SmartPower Stack is trademark of the SmartPower Stack Consortium. Any other names are the property of their respective owners.

Information in this document supersedes and replaces all information previously supplied.

Specifications are subject to change without notice.

© 2010-2014 - All rights reserved.

Prepared by: Rob Weber

Version: v13.0

Approved by: Mike Stibgen

Effective Date: 09/03/2014